



## **Table of Contents**

1. Introduction .....	3
2. Regulatory and safety requirements .....	5
3. Installation .....	7
4. Operation .....	11
5. Troubleshooting .....	25
6. Maintenance .....	27
7. Warehousing and Dismantling .....	30
8. Technical specifications .....	31

## 1. Introduction



### **DANGER**

It is necessary to read the whole manual carefully before doing any operation.  
Keor SPE must be used only in residential and commercial environments.

#### **1.1 Purpose of the manual**

The purpose of this manual is to provide the user with instructions for safely installing and using the Keor SPE UPS, also called "equipment" in the rest of the manual.  
Only skilled technicians can carry out ordinary maintenance procedures as explained in the appendix.

Extraordinary maintenance operations are not dealt with because they are the sole preserve of the LEGRAND Technical Support Service.

The intended use and configurations envisaged for the equipment as shown in this manual are the only ones allowed by the Manufacturer.

Any other use or configuration must be previously agreed with the Manufacturer in writing, and in this case the written agreement will be attached to the installation and user manuals.

The original text of this publication, drafted in English, is the only reference for the resolution of disputes of interpretation linked to translations into other languages.

#### **1.2 Update of the manual**

The manual reflects the state of the art when the equipment was put onto the market. The publication conforms to the directives current on that date. The manual cannot be considered inadequate when new standards come into force or modifications are made to the equipment.

Any addition to the manual the Manufacturer considers appropriate to send to the users, must be kept together with the manual of which they will become an integral part.

The version of the manual updated to its latest release is available on the Internet at <https://ups.legrand.com>

#### **1.3 Guarantee terms**

The guarantee terms may vary depending on the country where the UPS is sold. Check the validity and duration with LEGRAND's local sale representative.

If there should be a fault in the product, contact the LEGRAND Technical Support Service which will provide all the instructions on what to do.

Do not send anything back without LEGRAND's prior authorization.

LEGRAND is not responsible for costs such as:

- losses of profits or earnings.
- losses of equipment, data, or software.
- claims by third parties.
- any damage to persons or things due to improper use, unauthorized technical alterations, or modifications.
- any damage to persons or things due to installations where the full compliance with the standard regulating the specific usage applications have not been guaranteed.

The Manufacturer declines all indirect or direct responsibility arising from:

- assembly and cabling made by personnel not fully qualified according to national standards to work on equipment presenting electrical hazards.

- failure to observe the installation and maintenance instructions and use of the equipment which differs from the specifications in the manuals.
- use by personnel who have not read and thoroughly understood the content of the user manual.
- use that does not comply with the specific standards used in the country where the equipment is installed.
- modifications made to the equipment, software, functioning logic unless they have been authorized by the Manufacturer in writing.
- repairs that have not been authorized by the LEGRAND Technical Support Service.
- damage caused intentionally, through negligence, by acts of God, natural phenomena, fire, or liquid infiltration.

### **1.4 Copyright**

The information contained in this manual cannot be disclosed to any third party. Any partial or total duplication of the manual by photocopying or other systems, including electronic scanning, which is not authorized in writing by the Manufacturer, violates copyright conditions and may lead to prosecution. LEGRAND reserves the copyright of this publication and prohibits its reproduction wholly or in part without previous written authorization.

## 2. Regulatory and safety requirements

This section contains important safety and operating instructions that should always be followed during the installation, use and maintenance of the UPS.



### **DANGER**

The UPS operates with dangerous high voltages. Only skilled technicians qualified and authorized by LEGRAND must perform ordinary maintenance operations. Extraordinary maintenance operations must be carried out by LEGRAND Technical Support Service personnel.

- This product should be installed in compliance with installation rules, preferably by a qualified electrician. Incorrect installation and use can lead to risk of electric shock or fire. Before carrying out the installation, read the instructions and take account of the product's specific mounting location. Do not open up, dismantle, alter or modify the device except where specifically required to do so by the instructions. All Legrand products must be opened and repaired exclusively by personnel trained and approved by Legrand. Any unauthorised opening or repair completely cancels all liabilities and the rights to replacement and guarantees. Use only Legrand brand accessories.
- Ensure that the mains voltage, frequency, and output load match those of the UPS (check the product label and the technical specifications).
- If any visible damage is found on the product during the unpacking operation, do not install the UPS and return it to your reseller or distributor.
- Before supplying any load equipment, ensure the UPS is connected to a grounded mains socket.
- Do not attempt to open or disassemble the UPS; there are no user replaceable parts. Opening the case will void the warranty and introduces the risk of electric shock.
- Make sure the UPS is completely turned off when it is transported.
- The detachable power supply cable acts as a separation device. The mains socket must be installed near the UPS and must be easily accessible.
- In case of a mains power supply failure, do not unplug the input cord. Earth continuity must be ensured to the connected loads.
- Do not plug non-computer-related items such as medical, life-support and house electric equipment to the UPS output.
- Do not plug laser printers to the UPS outlets due to their high start-up current.
- The UPS functions with TT and TN systems.
- In case of emergency, immediately turn off the UPS and unplug the input cord from the mains.
- Do not allow any liquid or foreign object to enter the UPS.
- The UPS is intended for indoor installation in a ventilated, controlled indoor environment with a range of temperature between 0°C (+32°F) and +40°C (+104°F) and non-condensing humidity <95%.
- Do not install the UPS in locations with sparks, smoke, and hazardous gas or where there is water and excessive humidity. Dusty, corrosive, and salty environments can damage the UPS.
- Do not plug the UPS input into its own output.
- Do not attach a power strip or surge suppressor to the UPS to avoid potential overloads.
- Ensure that the output cables are not longer than 10 meters.
- Keep a clearance of 20 cm around the UPS for airflow. Avoid exposing it to direct sunlight or installing it near heat emitting appliances.
- Do not place the UPS near equipment that generate strong electromagnetic fields or sensible to electromagnetic fields.
- The batteries should be recharged every 3 months if the UPS is not used. To do so, connect the input cord to a grounded mains socket.
- To safeguard the batteries life, the UPS should be used in an environment with a temperature range between +20°C (+68°F) and +25°C (+77°F).
- The UPS is equipped with an auto-restart system. In case of return of the input mains after the end of battery operation, the UPS turns on to normal operation by supplying the output loads.
- The UPS is equipped with an automatic backfeed protection system.

- When installing the equipment, ensure that the sum of the leakage current of the UPS and the connected equipment does not exceed 3.5 mA.

**CAUTION**

The batteries inside the UPS are not user replaceable. Servicing of batteries must be performed only by electrical hazard authorized personnel.

A battery can present a risk of electrical shock and burns by high short-circuit circuit current. Failed batteries can reach temperatures that exceed the burn thresholds for touchable surfaces. The following precautions should be observed when working on batteries:

- a) remove watches, rings or other metal objects.
- b) use tools with insulated handles.
- c) wear rubber gloves and boots.
- d) do not lay tools or metal parts on top of batteries.
- e) disconnect the charging source prior to connecting or disconnecting battery terminals.
- f) determine if battery is inadvertently grounded. If inadvertently grounded, remove source from ground. Contact with any part of a grounded battery can result in electrical shock. The likelihood of such shock can be reduced if such grounds are removed during installation and maintenance (applicable to equipment and remote battery supplies not having a grounded supply circuit).
- g) never leave live cable terminals without an insulated protection.
- h) When replacing batteries, replace with the same type and number of batteries or battery packs. There is the risk of explosion if batteries are replaced by an incorrect type.

**CAUTION**

Do not dispose of batteries in a fire. The batteries may explode.

Do not open or mutilate batteries. Released electrolyte is harmful to the skin and eyes. It may be toxic. For the disposal requirements refer to local laws and relevant standards.

**WARNING**

Keor SPE is a category C2 UPS product according to the EN 62040-2









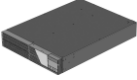

In a residential environment, this product may cause radio interference, in which case the user may be required to take additional measures.

### 3. Installation

#### 3.1 Package Inspection

During transportation, some unpredictable situations might occur. It is recommended to inspect the packaging. If you notice any damage, please immediately contact the dealer from whom you purchased the unit.

The UPS package must contain the following items:

ITEM		QTY
UPS		1
USB cable		1
Tower stands		2 (only 2U/3U)
Bracket ears		2
Quickstart		1
Handles		2 (only 2U/3U)
C19 to C20 cable (for 3 110 70-72)		1
C13 to C14 cable (for 3 110 65-66-67-68-69)		
C19 to Schuko cable (for 3 110 70-72)		1
C13 to Schuko cable (for 3 110 65-66-67-68-69)		
Pan head screws M5		4
Pan head screws M4		12 (2U/3U) 8 (1U)

## 3.2 Rack-mounting procedure

### 1U

1) Attach the included bracket ears to the lateral mounting holes of the UPS. Use the 8 M4 screws.

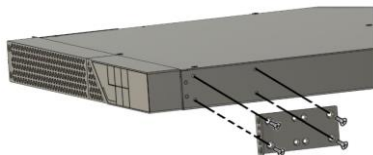

2) Insert the UPS into the rack and tighten the four M5 screws.



### 2U/3U

1) Attach the included bracket ears and handles to the lateral mounting holes of the UPS. Use the 12 M4 screws.

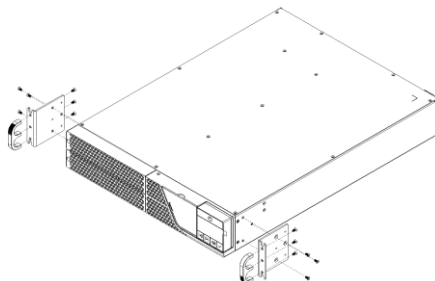

2) Insert the UPS into the rack and tighten the four M5 screws.

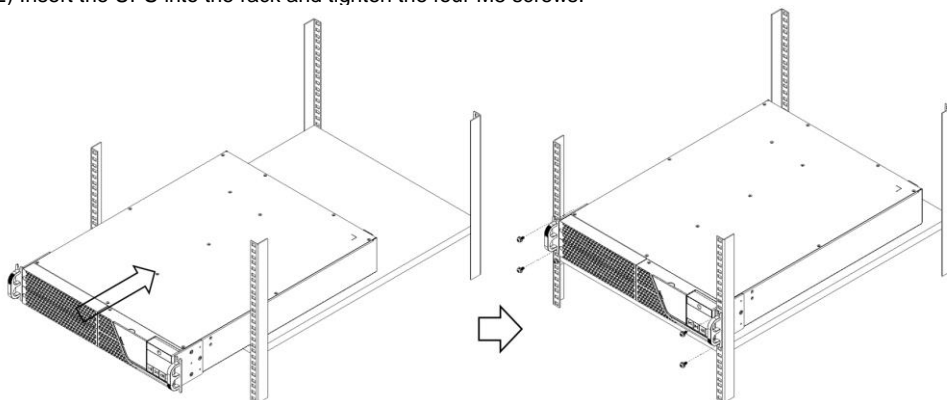



 **WARNING**

The handles are only used for pulling out the UPS from the cabinet rack. Do not lift up or carry the UPS by the handles.

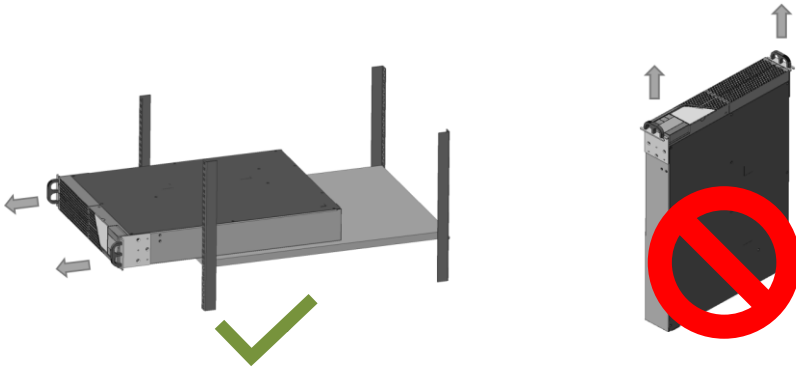

### 3.3 Tower Mounting Procedure (2U/3U)

1) Carefully lift the UPS up.

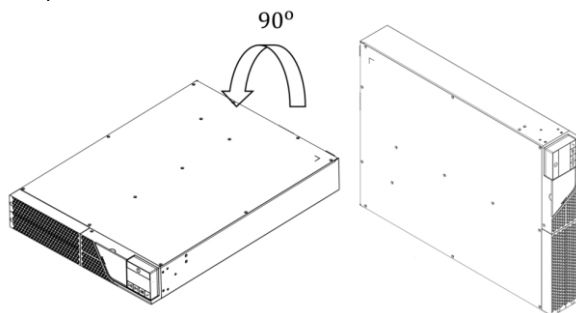

2) Place the UPS inside the tower stands.

3) Shift the LCD display shown in the picture and rotate it 90° clockwise. Then push the display back. The operation panel is installed well when a "click" sound is heard.

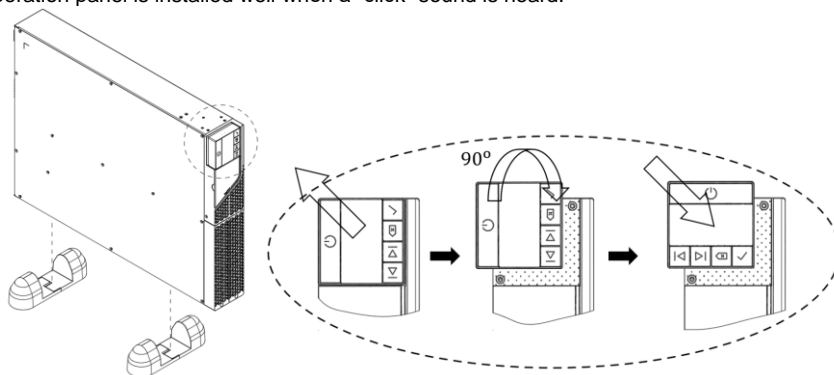

## 4. Operation

### 4.1 Rear View

#### 4.1.1 Model 1U

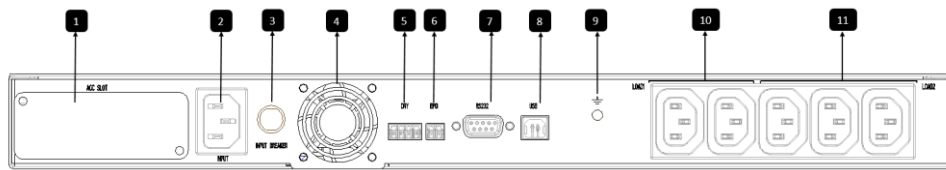

Rear view 1500 VA

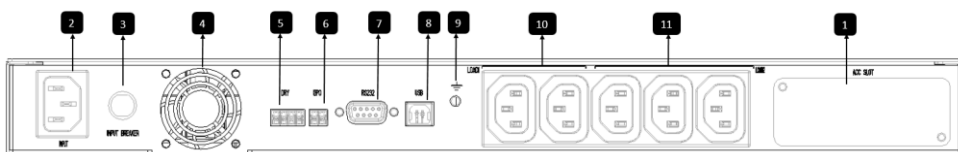

Rear view 750-1000 VA

No.	ITEM	No.	ITEM
1	Smart Slot	7	RS-232 Port
2	AC Input	8	USB Port
3	Input Fuse	9	Ground Terminal
4	Fan	10	Output Outlets_ Load 1
5	Dry Contacts	11	Output Outlets_ Load 2
6	EPO Port		

### 4.1.2 Model 2U/3U

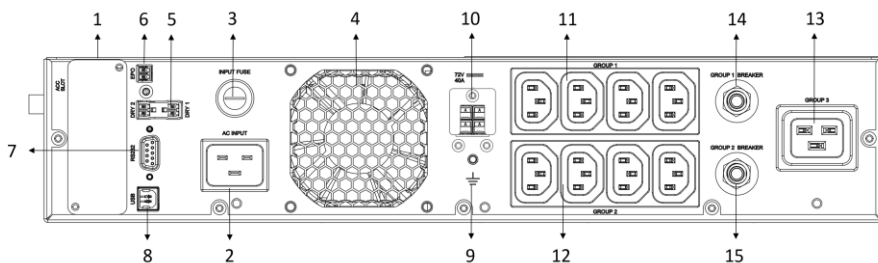

Rear view 3000 VA

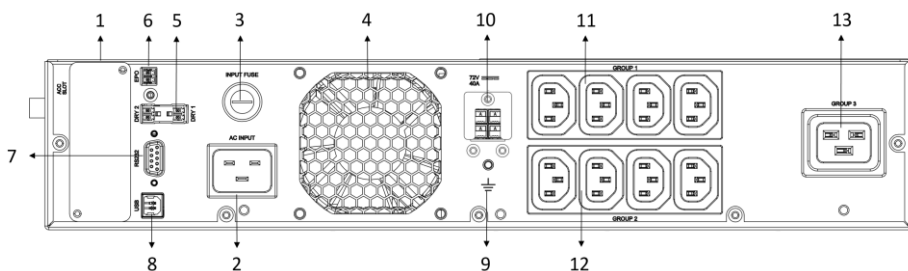

Rear view 2200 VA

No.	ITEM	No.	ITEM
1	Smart Slot	9	Ground Terminal
2	AC Input	10	EXB Connector
3	Input Fuse	11	C14 Output _Group 1
4	Fan	12	C14 Output _Group 2
5	Dry Contacts	13	C19 Output _Group 3
6	EPO Port	14	Breaker _Group 1
7	RS-232 Port	15	Breaker _Group 2
8	USB Port		

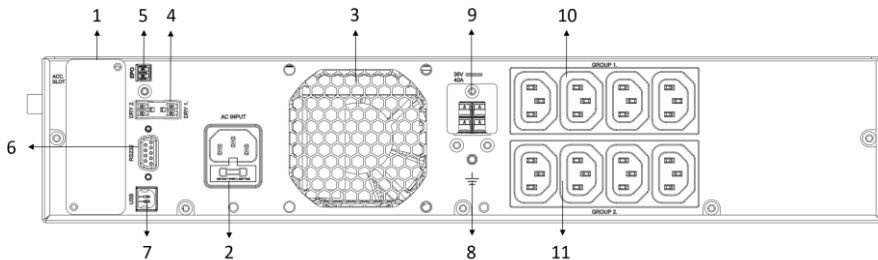

Rear view 1500/1000 VA

No.	ITEM	No.	ITEM
1	Smart Slot	7	USB Port
2	AC Input with fuse	8	Ground Terminal
3	Fan	9	EXB Connector
4	Dry Contacts	10	C14 Output_Group 1
5	EPO Port	11	C14 Output_Group 2
6	RS-232 Port		

### 4.2 Start-up procedure

#### 4.2.1 Normal mode

1. Ensure that the mains power supply to be used has a suitable voltage/frequency and an upstream protection rated at either 10A or 16 A (according to the UPS power).
2. Make sure that EPO contact is installed correctly as configured in the menu.
3. Plug the UPS power cord on the UPS inlet on one side and on the mains power supply socket on the other side.
4. The UPS recharges the battery every time is in standby mode. It is recommended to charge the battery at least six hours before connecting the loads.
5. Connect the loads to the UPS outlets. Ensure that the power of the loads can be managed by the UPS.
6. Press the ON/OFF button for 1 second to start-up the UPS and power the loads. The led bar is lit in green with a 1-second-long acoustic signal.

#### **INDICATION**

The UPS has an auto-restart function. In case the mains power fails, and the UPS reaches the end of the back-up time, the load will be automatically powered when the mains power is back if the auto-start setting is enabled.

#### 4.2.2 Cold start

1. Make sure the internal battery is fully charged.
2. Connect the loads to the outlets.
3. Make sure that EPO contact is installed correctly as configured in the menu.
4. With the mains absent, press the ON/OFF button for 3 seconds to start-up the UPS and power the loads in battery mode.

#### **INDICATION**

The output frequency in this condition is the last one seen by the UPS when the mains input was present.



#### **WARNING**

The very first time the UPS is turned on after its purchase, it is not possible to do it in battery mode (cold start), otherwise the error LOC will appear on the display.

### 4.3 Mute button

When the buzzer is active, press the  button for 0.1 seconds to silence the current alarm. In case of a new alarm, the buzzer will be re-activated automatically. When the buzzer is muted, press the button for 0.1 seconds to turn it on again.

### 4.4 Shutdown

1. Press and hold the ON/OFF button until the UPS turns off.
2. The UPS stops powering the outlets.
3. Unplug the UPS from the mains power supply socket.

### 4.5 Battery test

It is possible to execute a manual battery test if the UPS is working in normal mode and the battery is fully charged.

Press and hold the  button for 3 seconds and release it after you hear one beep: the UPS will switch to battery mode and perform a 10-second battery test. After that, UPS will return to line mode.

If the test result is ok, the display will show PAS for 7 seconds, then return to the previously viewed data.





If the test result is abnormal, the display will show FAL for 7 seconds, then return to the previously viewed data. The no-battery/ battery replacement icon () will flash until the ON/OFF button (fault clear) is pressed.

In case of attempting to perform a battery test while the UPS is running in battery mode, the display will show noP for 7 seconds, then return to the previously viewed data.

### 4.6 Setup mode

It is possible to change some parameters of the UPS while the UPS is in standby or in normal mode.

Press and hold the  button for 3 seconds until there is one beep is heard and the SET icon is shown.

Use the  button to enter the parameter to be changed. As confirmation, the value on the digits will start to flash. Press the  button to exit from the parameter. While the selected value flashes, use  and  buttons to change the values of the parameter and confirm the value with the  button. As confirmation, there is one beep and the value on the digits stop to flash.

To exit the setup mode, press and hold the  button for 3 seconds. If no button is pressed, after 1 minute the UPS exits from the setup mode.

The following tables indicate the parameters that can be set in standby mode and in normal mode.

STANDBY MODE	
FUNCTION	DESCRIPTION
<b>SET + </b>	<p>Buzzer</p> <p>Possible values: on / oFF Default: on</p>
<b>EPO/roo</b>	<p>Setting for the EPO auxiliary contact.</p> <p>Main page EPO: Emergency auxiliary contact to turn off the UPS in case of emergency roo: UPS remote turn on/off</p> <p>Subpage nC: contact normally closed nO: contact normally opened</p> <p>Default: EPO nC</p>
<b>SET + BATT + NUM</b>	<p>Total number of battery strings installed (internal + external)</p> <p>Possible values:</p> <ul style="list-style-type: none"> <li>• 1 to 9 (1000VA and 1500VA)</li> <li>• 1 to 5 (2200VA and 3000VA)</li> </ul> <p>Default: 1</p> <p>(only for 2U/3U)</p>
<b>SET + OUT + V</b>	<p>Output voltage</p> <p>Possible values: 200/208/220/230/240 V Default: 230V</p>
<b>SET + IN + OUT</b>	<p>Auto Restart function</p> <p>Possible values: on / oFF Default: on</p>

### INDICATION





If there are external battery cabinets installed, it is important to set up the total number of strings installed to have a correct calculation of the backup time in stored energy mode.

The UPS has always 1 string installed. The external battery cabinets have the following number of strings: 3 110 74 and 3 110 75 - 2 strings ; 3 110 76 and 3 100 77 - 1 string.

NORMAL MODE	
FUNCTION	DESCRIPTION
<b>SET + </b>	Buzzer Possible values: on / oFF Default: on
<b>SET + LOAD 1</b>	Turn on/off load 1 bank  Possible values: on / oFF Default: on  (only for 1U)
<b>SET + LOAD 2</b>	Turn on/off load 2 bank  Possible values: on / oFF Default: on
<b>SET + BATT + NUM</b>	Total number of battery strings installed (internal + external)  Possible values: <ul style="list-style-type: none"> <li>• 1 to 9 (1000VA and 1500VA)</li> <li>• 1 to 5 (2200VA and 3000VA)</li> </ul> Default: 1  (only for 2U/3U)
<b>SET + OUT + V</b>	Output voltage  Possible values: 200/208/220/230/240 V Default: 230V
<b>SET + IN + OUT</b>	Auto Restart function  Possible values: on / oFF Default: on



#### 4.7 Multi-function buttons

	<p><b>ON / OFF</b></p> <p>The button has three functions:</p> <ol style="list-style-type: none"> <li>1. <b>Turn on the UPS</b></li> <li>2. <b>Turn off the UPS</b></li> <li>3. <b>Fault Clear</b></li> </ol> <p>When the UPS has a fault condition, press and hold the button for 1 second, release it after one beep, and the UPS will clear the fault condition</p>
	<p><b>LEFT</b></p> <p>Press the button for 0.1 second to:</p> <ul style="list-style-type: none"> <li>• Normal mode: go to the previous display</li> <li>• Setup mode: decrease a number or change a setting value</li> </ul>
	<p><b>RIGHT</b></p> <p>Press the button for 0.1 second to:</p> <ul style="list-style-type: none"> <li>• Normal mode: go to the next display</li> <li>• Setup mode: increase a number or change a setting value</li> </ul>
	<p><b>ESC</b></p> <p>The button has three functions:</p> <ol style="list-style-type: none"> <li>1. <b>Exiting the Setup Mode</b></li> </ol> <p>In Setup Mode, press and hold the button for 3 seconds to exit the Setup Mode</p> <ol style="list-style-type: none"> <li>2. <b>Exit setting entry without confirm</b></li> </ol> <p>In Setup Mode, press the button for 0.1 seconds to exit the current setting entry without confirm the changes</p> <ol style="list-style-type: none"> <li>3. <b>Battery Test</b></li> </ol> <p>Execute a manual battery test (normal mode)</p>
	<p><b>ENTER</b></p> <p>The button has three functions:</p> <ol style="list-style-type: none"> <li>1. <b>Mute button</b></li> </ol> <p>To silence an alarm (normal mode)</p> <ol style="list-style-type: none"> <li>2. <b>Enter the Setup Mode</b></li> </ol> <p>Press and hold the button for 3 seconds until one beep and the SET icon will be turned on</p> <ol style="list-style-type: none"> <li>3. <b>Confirm</b></li> </ol> <p>In Setup Mode, press the button for 0.1 seconds to:</p> <ul style="list-style-type: none"> <li>• Enable the editing of the current setting. As confirmation, the value on the digits will start to flash.</li> <li>• Save the changes of the current setting. As confirmation, there is one beep and the value on the digits stop to flash.</li> </ul>

## 4.8 LCD Display

### 4.8.1 Parameters

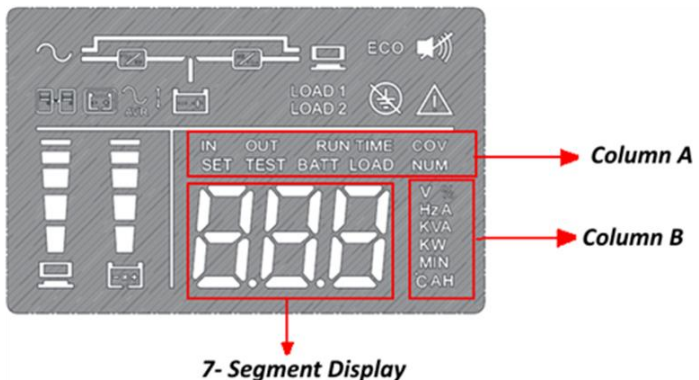





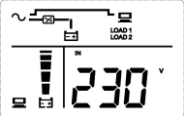
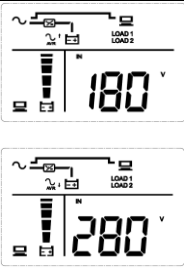
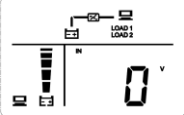



Column A	Column B	DESCRIPTION
IN	V	Input voltage
	Hz	Input frequency
LOAD	°C	Internal temperature (Celsius degrees)
	%	Total load value, in percentage
	kVA	Total load value (kVA)
RUN TIME	kW	Total load value (kW)
	MIN	Remaining back-up time with the current load (minutes)
BATT	%	Battery Charge level
	V	Battery voltage
	NUM	Total number of battery strings installed internal + external (only for 2U/3U)
OUT	V	Output voltage
	Hz	Output frequency
SET	(various)	The UPS is in the setup mode
TEST		Battery test in progress

### 4.8.2 Working Diagrams

DIAGRAM	MODE	DESCRIPTION
	Standby	The UPS is connected to the mains and the batteries are kept charged. The loads are not powered.
	Normal	The loads are powered directly from the mains while the batteries are kept charged.
	AVR	The input voltage is out of the set window. The internal transformer increases or decreases the output voltage.
	Battery	Mains absent. The loads are powered from the batteries.

### 4.8.3 Icons

ICON	NAME	DESCRIPTION
	AC power	<p>Indicates the input source status.</p> <ul style="list-style-type: none"> <li>• <b>ON:</b> the AC input is within the acceptable input range</li> <li>• <b>Flashing:</b> the AC input is out of the acceptable input range, but it is still enough to charge the battery</li> <li>• <b>OFF:</b> the AC input is out of the acceptable input range and is not enough to charge the battery. It means that UPS is working on battery mode.</li> </ul>
	Load banks	<p>Indicates the output status.</p> <ul style="list-style-type: none"> <li>• <b>ON:</b> The load bank 1 or 2 is powered</li> <li>• <b>OFF:</b> The load bank 1 or 2 is not powered</li> </ul>
	Battery	<p>Indicates the battery status.</p> <ul style="list-style-type: none"> <li>• <b>ON:</b> Battery is normal.</li> <li>• <b>Flashing:</b> Battery abnormal / disconnected</li> </ul>
	AVR	The UPS is stabilizing the output voltage.
	Buzzer mute	The buzzer is disabled
	Warning	Indicates that there is an error Refer to par. 5 of the manual for the Fault Error Codes.
	Load Level Bar	<p>Indicates the level of the load.</p> <ul style="list-style-type: none"> <li>• <b>ON:</b> the bar graph illuminates according to the load level            1%-20%: the first segment will illuminate            21%-40%: the first two segments will illuminate.            41%-60%: the first three segments will illuminate.</li> </ul>

		<p>61%-80%: the first four segments will illuminate. 81%-100%: all segments will illuminate. &gt; 100%: all segments will be illuminated and will flash</p> <ul style="list-style-type: none"> <li>• <b>Flashing:</b> there is an overload condition</li> </ul>
	<p style="text-align: center;">Battery Level Bar</p>	<p>Indicates the level of the battery charge.</p> <ul style="list-style-type: none"> <li>• <b>ON:</b> the bar graph illuminates according to the remaining battery capacity</li> </ul> <p><b>Charging mode:</b> 0%-19%: the first segment will flash 20%-39%: the first segment will be illuminated, the second segment will flash 40%-59%: the first 2 segments will be illuminated, the third segment will flash 60%-79%: the first 3 segments will be illuminated, the 4<sup>th</sup> segment will flash 80%-99%: the first 4 segments will be illuminated, the 5<sup>th</sup> segment will flash 100%: all 5 segments will be illuminated</p> <p><b>Discharging mode:</b> 100%: all 5 segments will be illuminated 99%-80%: the first 4 segments will be illuminated 79%-60%: the first 3 segments will be illuminated 59%-40%: the first 2 segments will be illuminated 39%-20%: the first segment will be illuminated 19%-1%: the first segment will flash 0%: no segments are illuminated</p> <ul style="list-style-type: none"> <li>• <b>Flashing:</b> the first segment flashes when a low-battery situation occurs</li> </ul>

#### 4.9 LED bar and Alarm Indicators

LED BAR			ALARM	UPS STATUS
Green	Yellow	Red		
Fixed (Flashing)	-	-	-	mains present and regular, batteries recharging (The bar is flashing only if the mains is present and load 1 or 2 bank is turned off)
-	Fixed	-	Intermittent every 0.5 sec	Warning status
-	Fixed	-	Intermittent every 5 sec	UPS operating in battery mode with battery status >50%
-	Fixed	-	Intermittent every 2 sec	UPS operating in battery mode with battery status <25%
-	Flashing	-	Intermittent every 0.5 sec	End of back-up time
-	Fixed	-	Intermittent every 5 sec	Battery Test
-	-	Fixed	Intermittent every 0.5 sec	- Failure - Battery overload (battery mode) - EPO activation
-	-	Fixed	Continuous sound	Overload shutdown fault
-	Flashing	-	Intermittent (various frequency)	Mains absent and load 1 or 2 bank is turned off

### 4.10 Communication ports

The UPS has a standard RS232 serial port, a USB 2.0 type B port and one SNMP slot. It can be connected to most NAS devices and computers. By connecting the UPS to a computer, it is possible to perform functions like:

- displaying all operating and diagnostic data in case of problems.
- setting special functions like the control of the load banks.
- performing automatic shutdown of all computers powered by the UPS (if connected to the TCP/IP network).

Visit the website [ups.legrand.com](http://ups.legrand.com) for more information on network interfaces and software.

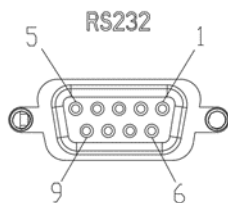

RS232 CONNECTOR :

PIN NO.	PIN DEFINE
1	NA
2	RX
3	TX
4	NA
5	GND
6	NA
7	NA
8	NA
9	NA

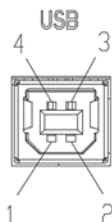

USB CONNECTOR :

PIN NO.	PIN DEFINE
1	SUB_VDD
2	DM
3	DP
4	GND_SELV

### 4.11 EPO/ROO

The rear part of the UPS includes a contact that can be configured to be used as:

- Emergency Power Off (EPO) to connect an emergency pushbutton to turn off the UPS.
- Remote On/Off (roo) to cable a contact to turn off and on the UPS remotely.
- 

The default setting of the contact is nC (normally closed). If you want to change the default status to nO (normally open), follow par. 4.6 to enter setup mode.

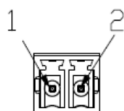

PIN NO.	PIN DEFINE
1	+VCC_SELV
2	GND

1U

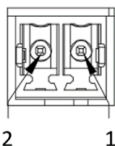

PIN NO.	PIN DEFINE
1	EPO
2	GND

2U/3U

### 4.12 Dry Contacts

The rear part of the UPS includes two dry contacts which indicate the following status:

- Pin 1-2: battery low. When the UPS battery is low, the contact changes status. The default setting is nO (normally open).
- Pin 3-4: battery mode. When the UPS turns to stored energy mode, the contact changes status. The default setting is nO (normally open).



PIN NO.	PIN DEFINE
1	DRY_LOW
2	GND
3	DRY_ON
4	GND

1U

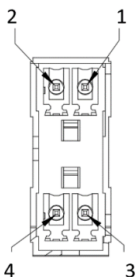

PIN NO.	PIN DEFINE
1	GND
2	DRY_LOW
3	GND
4	DRY_ON

2U/3U



## 5. Troubleshooting

INDICATION	POSSIBLE CAUSE	SOLUTION
The UPS works on battery mode even though the mains power is available	The input fuse blew up	Replace the fuse with a new one
	The mains power supply socket is not supplying power to the UPS	Check if the UPS works on another socket. If so, have the first mains power supply socket checked by a skilled technician.
	The input cord is not properly connected	Check that the input cord is properly connected to the inlet and to the mains socket
	Mains out of the allowed UPS input range	A skilled technician should check the mains
Continuous sound alarm sound with the UPS working in normal mode	Overload	Disconnect some non-critical loads from the UPS outlets until the overload ceases
The UPS is working normally but the loads are not powered	-	Check that all power cords are properly connected to the outlets and to the load. If the problem persists, contact the LEGRAND Technical Support Service
The UPS does not operate correctly in battery mode: it shuts down immediately or the backup time is greatly reduced	The UPS worked in stored energy mode till the end of operation	Recharge the batteries for at least six hours by connecting the UPS to the mains
	The UPS has not been used for many months	Recharge the batteries at least six hours by connecting the UPS to the mains. If the batteries are no longer working, contact a skilled technician to replace them.
	The battery has run down due to being used frequently, to ambient conditions, or to having exceeded its average service life	Contact a skilled technician or the LEGRAND Technical Support Service to replace the batteries
Strange noise or smell	UPS fault	Shut down immediately the UPS. Unplug the UPS from the mains socket and contact the LEGRAND Technical Support Service

**Fault error codes**

ERROR CODE	Description	Does the error turn off the UPS?
LOC	When the UPS is brand new, it is protected from an unwanted power-up during transportation. The very first start-up of the UPS is possible only with the power cord connected to the mains.	-
E01	Inverter voltage high	Y
E02	Inverter voltage low	Y
E03	Output voltage is short	Y
E04	Internal fault (only for 2U/3U)	Y
E05	Backfeed relay fault (only for 2U/3U)	Y
E06	Inverter relay weld (only for 1U)	Y
E07	The DC offset output voltage is high (only for 1U)	Y
E17	Charger voltage high	N
E18	EEPROM communication abnormal (only for 1U)	N
E19	Overheating	Y
E20	Overload	Y
E22	Battery disconnected	N
E23	Battery weak	N
E24	Charger fault (only for 1U)	N
E25	Battery voltage low	N
E26	End of operation in stored energy mode	Y
E27	Inverter overtemperature	Y
E28	Fan blocked	N
E29	EPO activated	Y

## 6. Maintenance

### 6.1 UPS Cleaning

Regularly clean the UPS, especially the slits and openings, to ensure that the air freely flows into the UPS to avoid overheating. If necessary, use an air-gun to clean the slits and openings to prevent any object from blocking or covering these areas.

### 6.2 UPS Regular Inspection

Regularly check the UPS and inspect:

- whether the UPS, LEDs, and alarm functions are operating normally.
- whether battery voltage is normal. If the battery voltage is too high or too low, find the root cause.

### 6.3 Battery Replacement



#### CAUTION

All operations listed in this paragraph must be carried out only by a SKILLED TECHNICIAN.

This definition refers to people who have specific technical qualification and are aware of the methods of installing, assembling, repairing, and using the equipment safely.

The skilled technician is qualified according to national safety standards to work under dangerous electrical voltage and uses the personal protective equipment required by national safety standards.



#### DANGER

A battery can present a risk of electrical shock and high short circuit current.

Before the replacement, it is mandatory the reading of chapter 2 about safety requirements.

Batteries may only be replaced with the same number and type. Batteries must be brand new.

If the battery brand is different from the one originally installed by Legrand, the estimated battery autonomy indicated on the display of the UPS may not be reliable.

**DURING THE HOT-SWAP BATTERY REPLACEMENT, THE LOAD IS NOT PROTECTED IF THE INPUT POWER FAILS.**

- Remove the UPS's front plastic panel.

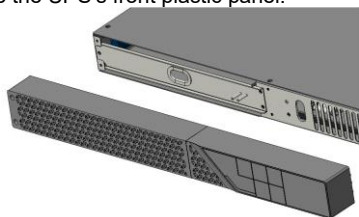

1U

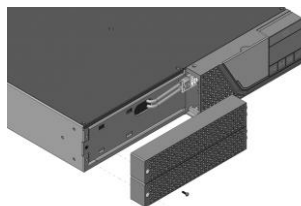

2U/3U

- Disconnect the battery cables

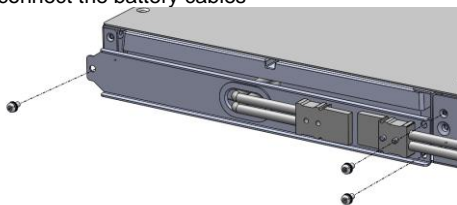

1U

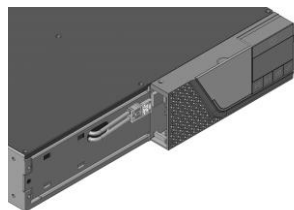

2U/3U

- Remove the battery cover

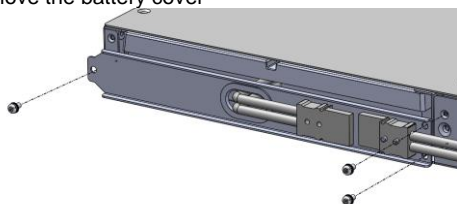

1U

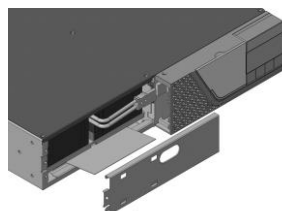

2U/3U

- Pull out the blister to take out the internal batteries by using the plastic tab. Do not use the battery wire to pull out the battery pack.

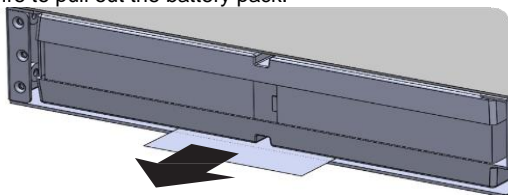

1U

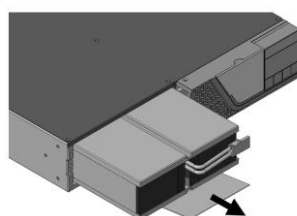

2U/3U

### 6.4 Battery information

Model	Battery Type
750 VA (1U)	4 x Minhua type MS7-6
1000 VA (1U)	
1500 VA (1U)	
1000 VA (2U)	6 x Minhua type MS7-12
1500 VA (2U)	6 x Minhua type MS9-12
2200 VA (2U/3U)	6 x Minhua type MS7-12
3000 VA (2U/3U)	6 x Minhua type MS9-12

### 6.5 Fuse replacement

The input socket includes a fuse for the 1000-1500 VA models 2U. If the fuse must be replaced, unplug the input cord, and use a screwdriver to remove the fuse from the holder.

Instead, there is a dedicated fuse holder in the rear part of the UPS for the other models.

If the fuse must be replaced, use the type indicated in the next table.

Model	INPUT FUSE
750 VA	F10AH250V (5 x 20mm)
1000 VA	
1500 VA	
2200 VA	F15AH250V (6.3 x 32mm)
3000 VA	F20AH250V (6.3 x 32mm)

## 7. Warehousing and Dismantling

### 7.1 Warehousing

The UPS can be stored in an environment with a room temperature between  $-20^{\circ}\text{C}$  ( $-4^{\circ}\text{F}$ ) and  $+50^{\circ}\text{C}$  ( $+122^{\circ}\text{F}$ ) and humidity less than 90% (not condensing).

However, it is recommended to store the UPS in an environment with a room temperature between  $+20^{\circ}\text{C}$  ( $+68^{\circ}\text{F}$ ) and  $+25^{\circ}\text{C}$  ( $+77^{\circ}\text{F}$ ) to preserve the battery life.

The battery installed inside the UPS is lead/acid sealed and does not require maintenance (VRLA). The battery should be charged for 8 hours every 3 months by connecting the UPS to the mains supply socket. Repeat this procedure every two months if the storage ambient temperature is above  $+25^{\circ}\text{C}$  ( $+77^{\circ}\text{F}$ ).

#### **INDICATION**

The UPS must never be stored if batteries are partially or totally discharged. LEGRAND is not liable for any damage or bad functioning caused to the UPS by wrong warehousing.

### 7.2 Dismantling



Dismantling and disposal operations must be carried out only by a qualified electrician. The instructions in this chapter are to be considered indicative: in every country there are different regulations regarding the disposal of electronic or hazardous waste such as batteries. It is necessary to strictly adhere to the standards in force in the country where the equipment is used. Do not throw any component of the equipment in the ordinary rubbish.

#### 7.2.1 Battery disposal



Batteries must be disposed of in a site intended for the recovery of toxic waste. Disposal in the traditional rubbish is not allowed. Apply to the competent agencies in your countries for the proper procedure.



A battery may constitute a risk of electric shock and high short-circuit current. When working on batteries, the prescriptions indicated in chapter 2 must be adhered to.

#### 7.2.2 UPS dismantling

The dismantling of the UPS must occur after the dismantling of the various parts it consists of. For the dismantling operations, it is necessary to wear Personal Protective Equipment. Sub-divide the components separating the metal from the plastic, from the copper and so on according to the type of selective waste disposal in the country where the equipment is dismantled. If the dismantled components must be stored before their disposal, be careful to keep them in a safe place protected from atmospheric agents to avoid soil and groundwater contamination.

#### 7.2.3 Electronic component dismantling

For the disposal of electronic waste, it is necessary to refer to the relevant standards.



This symbol indicates that in order to prevent any negative effects on the environment and on people, this product should be disposed of separately from other household waste, by taking it to authorised collection centres, in accordance with the EU countries local waste disposal legislations. Disposing of the product without following local regulations may be punished by law. It is recommended to check that this equipment subject to WEEE legislations in the country where it is used.

## 8. Technical specifications

### 8.1 Keor SPE R/T 1U

#### GENERAL CHARACTERISTICS

	3 110 65	3 110 66	3 110 68
	Keor SPE R/T 750	Keor SPE R/T 1000	Keor SPE R/T 1500
Nominal power (VA)	750	1000	1500
Power Factor	0.7		
Active power (V <sub>IN</sub> 220/230/240V <sub>AC</sub> ) (W)	525	700	1050
Active power (V <sub>IN</sub> 200/208V <sub>AC</sub> ) (W)	525	630	945
Technology	Line interactive (VI)		
Waveform	Pure sinewave		
Transfer time (ms)	6-8 (typical) 10 (maximum)		
Insulation class (IEC 61140)	I		
Overvoltage category	OVC II		
Rated short-time withstand current (kA)	1 ≤ I <sub>cw</sub> ≤ 6		

#### INPUT ELECTRICAL CHARACTERISTICS

	3 110 65	3 110 66	3 110 68
	Keor SPE R/T 750	Keor SPE R/T 1000	Keor SPE R/T 1500
Rated voltage (V <sub>AC</sub> )	200-240 ; ~ 1ph		
Range of voltage (V <sub>AC</sub> )	175 to 288 (at full load)		
Rated frequency (hz)	50 / 60 auto-sensing		
Range of frequency (hz)	47-63		
Maximum current (A)	3.55	4.73	7.11
Replaceable fuse	F10AH250V (5 x 20mm)		
Inlet	1 x IEC C14		

### OUTPUT ELECTRICAL CHARACTERISTICS

	3 110 65 Keor SPE R/T 750	3 110 66 Keor SPE R/T 1000	3 110 68 Keor SPE R/T 1500
Rated voltage (V)	230 ; ~ 1ph Battery mode: ±5%		
Rated frequency (Hz)	50 / 60 ± 1% (battery mode)		
Maximum current (A)	3.41	4.54	6.82
Overload capacity	Normal mode <106% : continuous <120% : 5min <150% : 1min >=150% : 10sec  Battery mode <105% : continuous <120% : 10sec >=120% : immediate shut-down		
Outlets	5 x IEC C13		
Efficiency	up to 98%		

### BATTERIES AND BATTERY CHARGER CHARACTERISTICS

	3 110 65 Keor SPE R/T 750	3 110 66 Keor SPE R/T 1000	3 110 68 Keor SPE R/T 1500
Number of batteries	4		6
String (V)	1x24		1x36
Capacity (Ah)	7		
Battery type	3 cells VRLA valve-regulated lead-acid, maintenance free		
Back-up time at 50% load (min)	> 10min		
Charge current (A)	1.2 max		
Charging time	6 hours to 90% (after discharge with 50% fully resistive load)		
Battery cut-off (V)	1.6 V/cell at medium/full load 1.83V/cell at light load		
Battery replacement	Hot-swappable		
Battery extension	no		



### FEATURES

	3 110 65 Keor SPE R/T 750	3 110 66 Keor SPE R/T 1000	3 110 68 Keor SPE R/T 1500
Visual Interface	LCD display with five pushbuttons and LEDs		
Communication Ports	Dry Contacts RS232 USB 2.0 type B Communication slot for SNMP Card		
Protections	Electronic protection against overloading and short-circuiting and excessive battery discharge Shutdown on reaching operating limit and overheating Automatic shutdown due to protection triggering Backfeed protection embedded Emergency Power Off (EPO) adjustable as NC/NO via LCD		
Outputs	2 programmable banks		

### MECHANICAL CHARACTERISTICS

	3 110 65 Keor SPE R/T 750	3 110 66 Keor SPE R/T 1000	3 110 68 Keor SPE R/T 1500
Dimensions W x D x H (mm)	440 x 44 x 513		440 x 44 x 557
Rack dimensions	1 U		
Net weight without batteries (kg)	13,5		16,8

### ENVIRONMENTAL CONDITIONS

	3 110 65	3 110 66	3 110 68
	Keor SPE R/T 750	Keor SPE R/T 1000	Keor SPE R/T 1500
Operating temperature (°C)	0 ÷ +40 (+20 ÷ +25 recommended for longer battery life)		
Relative humidity during operation	< 95% non-condensing		
Storage temperature (°C)	-0 ÷ +50 (+20 ÷ +25 recommended to preserve battery life)		
Noise level at 1 meter (dBA)	< 40	< 45	
Protection Index (IEC 529)	IP 20		
Operating height	up to 1000m (3300 ft.) without derating 1% de-rating per +100m (330 ft.)		
Pollution degree	PD2		
Climatic class (EN 60721-3-3)	3K22		
Special climatic class (EN60721-3-3)	3Z2		
Biological class (EN60721-3-3)	3B2		
Mechanically active substances class (EN60721-3-3)	3S5		
Mechanical class (EN 60721-3-3)	3M11		

### REFERENCE DIRECTIVES AND STANDARDS

Marks	CE, EAC, CMIM, UKCA
Safety	2014/35/EU Directive EN 62040-1
EMC	2014/30/EU Directive EN 62040-2

### 8.2 Keor SPE R/T 2U/3U

#### GENERAL CHARACTERISTICS

	3 110 67 Keor SPE R/T 1000	3 110 69 Keor SPE R/T 1500	3 110 70 Keor SPE R/T 2200	3 110 71 Keor SPE R/T 2200	3 110 72 Keor SPE R/T 3000	3 110 73 Keor SPE R/T 3000
Nominal power (VA)	1000	1500	2200		3000	
Power Factor	0.8		0.9			
Active power (V <sub>IN</sub> 220/230/240V <sub>AC</sub> ) (W)	800	1200	1980		2700	
Active power (V <sub>IN</sub> 200/208V <sub>AC</sub> ) (W)	720	1080	1782		2400	
Technology	Line interactive (VI)					
Waveform	Pure sinewave					
Transfer time (ms)	6-8 (typical) 10 (maximum)					
Insulation class (IEC 61140)	I					
Overvoltage category	OVC II					
Rated short-time withstand current (kA)	1 ≤ I <sub>cw</sub> ≤ 6					

#### INPUT ELECTRICAL CHARACTERISTICS

	3 110 67 Keor SPE R/T 1000	3 110 69 Keor SPE R/T 1500	3 110 70 Keor SPE R/T 2200	3 110 71 Keor SPE R/T 2200	3 110 72 Keor SPE R/T 3000	3 110 73 Keor SPE R/T 3000
Rated voltage (V <sub>AC</sub> )	200-240 ; ~ 1ph					
Range of voltage (V <sub>AC</sub> )	175 to 288 (at full load)					
Rated frequency (hz)	50 / 60 auto-sensing					
Range of frequency (hz)	47-63					
Maximum current (A)	5.37	8.06	11.82		16.12	
Replaceable fuse	F10AH250V (5 x 20mm)		F15AH250V (6.3 x 32mm)		F20AH250V (6.3 x 32mm)	
Inlet	1 x IEC C14		1 x IEC C20			

### OUTPUT ELECTRICAL CHARACTERISTICS

	3 110 67	3 110 69	3 110 70	3 110 71	3 110 72	3 110 73
	Keor SPE R/T 1000	Keor SPE R/T 1500	Keor SPE R/T 2200	Keor SPE R/T 2200	Keor SPE R/T 3000	Keor SPE R/T 3000
Rated voltage (V)	230 ; ~ 1ph Battery mode: +6% , -10%					
Rated frequency (Hz)	50 / 60 ± 1% (battery mode)					
Maximum current (A)	4.55	6.82	10		13.64	
Overload capacity	Normal mode <105% : continuous <120% : 30sec <150% : 10sec >=150% : immediate shut-down  Battery mode <105% : continuous <120% : 10sec >=120% : immediate shut-down					
Outlets	8 x IEC C13			8 x IEC C13 + 1 x IEC C19		
Efficiency	up to 98%					

### BATTERIES AND BATTERY CHARGER CHARACTERISTICS

	3 110 67	3 110 69	3 110 70	3 110 71	3 110 72	3 110 73
	Keor SPE R/T 1000	Keor SPE R/T 1500	Keor SPE R/T 2200	Keor SPE R/T 2200	Keor SPE R/T 3000	Keor SPE R/T 3000
Number of batteries	3			6		
String (V)	1x36			1x72		
Capacity (Ah)	7	9	7		9	
Battery type	3 cells VRLA valve-regulated lead-acid, maintenance free					
Back-up time at 50% load (min)	> 10 min					
Charge current (A)	1.05	1.35	1.05		1.35	
Charging time	6 hours to 90% (after discharge with 50% fully resistive load)					
Battery cut-off (V)	1.6 V/cell at medium/full load 1.83V/cell at light load					
Battery replacement	Hot-swappable					
Battery extension	yes with 3 110 74	yes with 3 110 75	yes with 3 110 76		yes with 3 110 77	

### FEATURES

	3 110 67	3 110 69	3 110 70	3 110 71	3 110 72	3 110 73
	Keor SPE R/T 1000	Keor SPE R/T 1500	Keor SPE R/T 2200	Keor SPE R/T 2200	Keor SPE R/T 3000	Keor SPE R/T 3000
Visual Interface	LCD display with five pushbuttons and LEDs					
Communication Ports	Dry Contacts RS232 USB 2.0 type B Communication slot for SNMP Card					
Protections	Electronic protection against overloading and short-circuiting and excessive battery discharge Shutdown on reaching operating limit and overheating Automatic shutdown due to protection triggering Backfeed protection embedded Emergency Power Off (EPO) adjustable as NC/NO via LCD					
Outputs	1 programmable bank					

### MECHANICAL CHARACTERISTICS

	3 110 67	3 110 69	3 110 70	3 110 71	3 110 72	3 110 73
	Keor SPE R/T 1000	Keor SPE R/T 1500	Keor SPE R/T 2200	Keor SPE R/T 2200	Keor SPE R/T 3000	Keor SPE R/T 3000
Dimensions W x D x H (mm)	440 x 88 x 440		440 x 88 x 600	440 x 132 x 500	440 x 88 x 600	440 x 132 x 500
Rack dimensions	2 U		2 U	3 U	2 U	3 U
Net weight without batteries (kg)	16.9	17.5	28.3		29.5	

### ENVIRONMENTAL CONDITIONS

	3 110 67	3 110 69	3 110 70	3 110 71	3 110 72	3 110 73
	Keor SPE R/T 1000	Keor SPE R/T 1500	Keor SPE R/T 2200	Keor SPE R/T 2200	Keor SPE R/T 3000	Keor SPE R/T 3000
Operating temperature (°C)	0 ÷ +40 (+20 ÷ +25 recommended for longer battery life)					
Relative humidity during operation	< 95% non-condensing					
Storage temperature (°C)	-0 ÷ +50 (+20 ÷ +25 recommended to preserve battery life)					
Noise level at 1 meter (dBA)	< 50			< 55		
Protection Index (IEC 529)	IP 20					
Operating height	up to 1000m (3300 ft.) without derating 1% de-rating per +100m (330 ft.)					
Pollution degree	PD2					
Climatic class (EN 60721-3-3)	3K22					
Special climatic class (EN60721-3-3)	3Z2					
Biological class (EN60721-3-3)	3B2					
Mechanically active substances class (EN60721-3-3)	3S5					
Mechanical class (EN 60721-3-3)	3M11					

### REFERENCE DIRECTIVES AND STANDARDS

Marks	CE, EAC, CMIM, UKCA
Safety	2014/35/EU Directive EN 62040-1
EMC	2014/30/EU Directive EN 62040-2

LEGRAND  
Pro and Consumer Service  
BP 30076 - 87002  
LIMOGES CEDEX FRANCE  
[www.legrand.com](http://www.legrand.com)

Installer stamp

Legrand reserves at any time the right to modify the contents of this booklet and to communicate, in any form and modality, the changes brought to the same.